

## SPEC SHEET

### CMB10X20 (COMBO WALK-IN BOX)

External Dimensions: 9' 10"W x 19' 8"L x 7' 7"H

#### GENERAL SPECIFICATIONS

**PANELS:** 4" Thick foamed-in-place polyurethane insulation, cam-lock panels, tongue & groove design, 24 Ga. pre-painted white galvanized steel, CFC and HFC free materials, 10 year panel warranty and 1 year parts warranty,

**FLOOR (IF APPLICABLE):** 24 ga. pre-painted white galvanized steel, 600 lb/sq. ft. (foot traffic). Optional diamond plate recommended for hand-truck or pallet jack operation.

**DOOR:** 30"x77", 36"x77", 48"x77" door options, left or right hinged, self-closing, spring loaded hinge, flush-mounted, keyed locking door handle, 120V/1P/1A heater wire, pressure relief vent for freezers, 120V vapor proof light fixture provided loose (bulb not included).

**APPROVALS:** NSF/ANSI 7 Commercial Refrigerators and Freezers, UL723 Flame Spread and Smoke Development (Flame Spread Index 5, Smoke Developed Index 300), Department of Energy (DOE) Compliance and Certified, ASTM Test 518, ASTM Test E84

#### LAYOUT OPTIONS (Please select a layout)

CMB10X20-12C8F-36L36L

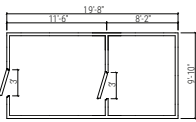

CMB10X20-12C8F-36L36R

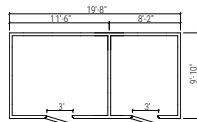

CMB10X20-12C8F-36R36R

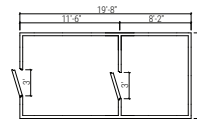

CMB10X20-12C8F-36R36L

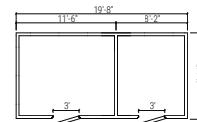

CMB10X20-10C10F-36L36L

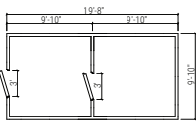

CMB10X20-10C10F-36L36R

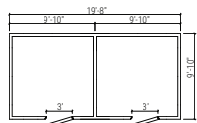

CMB10X20-10C10F-36R36R

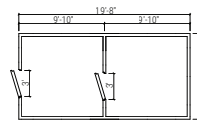

CMB10X20-10C10F-36R36L

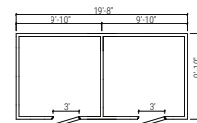

CMB10X20-13C7F-36R36R

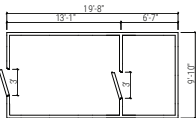

CMB10X20-15C5F-36R36R

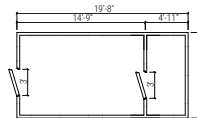

#### DOOR OPTIONS (Please select a door)

Select door width:

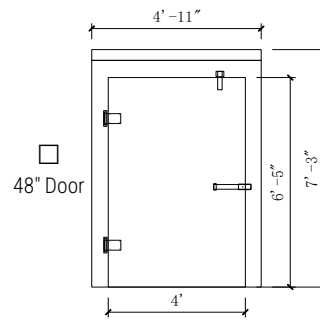
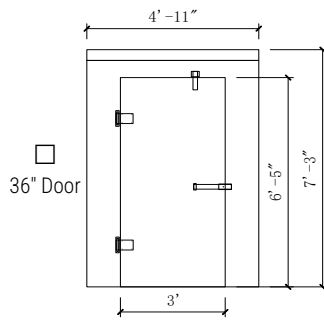
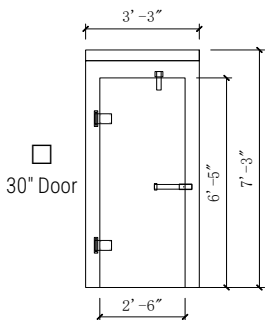

Select left/right hinge:

Left hinge

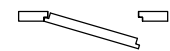

Right hinge

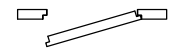

### ADDITIONAL OPTIONS

- Kick Plate (Interior and Exterior)
- 4 feet LED light (loose)
- Aluminum diamond plate for floor, 1/8" thick
- Aluminum diamond plate for floor, 1/4" thick
- Exterior ramp
- Rain roof membrane for outdoor application

### OPTIONAL REFRIGERATION SYSTEM (Please select a refrigeration type)

#### Remote Refrigeration (Turbo Air)



Turbo Air Outdoor Condensing Unit, 1 x Medium Temp and 1 x Low Temp, Air Cooled, 208-230V/60Hz/1Ph, Copeland Scroll Compressor, R404A, R407C, R448A / R449A.

Turbo Air Evaporator, Air Defrost, EC Motor, Pre-Assembled (R448A, R449A TXV, Solenoid Valve, Digital Temperature Controller), 115V/60Hz/1Ph.

Turbo Air Evaporator, Electric Defrost, EC Motor, Pre-Assembled (R448A, R449A TXV, Solenoid Valve, Digital Temperature Controller), 208-230V/60Hz/1Ph.

Condensing Unit and evaporator sizes vary depending on the combo split.

1 year parts warranty | Additional 4 years warranty available.

#### Top-Mount Refrigeration (Turbo Air)



Turbo Air Indoor Package Unit, Top-Mount, Smart 7, 1 x Medium Temp and 1 x Low Temp, 208-230V/60Hz/1Ph, R290.

Package Unit sizes vary depending on the combo split.

Blue Anti-corrosion-fin and Coated Copper Tube, Expansion Valve & Solenoid Valve, Hot Gas Defrost, Efficient Micro Channel Condenser Coil, Energy Efficient EC Motor.

Hot Gas Condensate System (Panel Opening Size varies depending on the Package Unit).

1 year parts and labor warranty | Additional 4 years warranty available.

### OPTIONAL DISPLAY GLASS DOORS

# of 24"x75" doors: \_\_\_\_\_

#### GENERAL SPECS:

Triple-pane for freezer, double pane for cooler

7 Wire shelves

Black frame and shelves

Left hinge doors (field reversible)

LED lighting



#### Net Opening Dimensions:

Set	Net Opening (Cooler or Freezer)	Electrical
5 Glass Door Set	124"x77.5"h	120V/60Hz/16A
4 Glass Door Set	99.5"x77.5"h	120V/60Hz/12A
3 Glass Door Set	75"x77.5"h	120V/60Hz/10A
2 Glass Door Set	50.5"x77.5"h	120V/60Hz/7A

### CUSTOMER APPROVAL

Name: \_\_\_\_\_

Signature: \_\_\_\_\_

Date: \_\_\_\_\_



899 Newark Tpke, Kearny, NJ 07032

Tel: (908) 315-3222

www.GalaxyGroupCorp.com

Email: contact@GalaxyGroupCorp.com