

SPEC SHEET

FWF8X21 (FREEZER WITH FLOOR)

External Dimensions: 8' 2"W x 21' 4"L x 7' 7"H

GENERAL SPECIFICATIONS

PANELS: 4" Thick foamed-in-place polyurethane insulation, cam-lock panels, tongue & groove design, 24 Ga. pre-painted white galvanized steel, CFC and HFC free materials, 10 year panel warranty and 1 year parts warranty,

FLOOR (IF APPLICABLE): 24 ga. pre-painted white galvanized steel, 600 lb/sq. ft. (foot traffic). Optional diamond plate recommended for hand-truck or pallet jack operation.

DOOR: 30"x77", 36"x77", 48"x77" door options, left or right hinged, self-closing, spring loaded hinge, flush-mounted, keyed locking door handle, 120V/1P/1A heater wire, pressure relief vent for freezers, 120V vapor proof light fixture provided loose (bulb not included).

APPROVALS: NSF/ANSI 7 Commercial Refrigerators and Freezers, UL723 Flame Spread and Smoke Development (Flame Spread Index 5, Smoke Developed Index 300), Department of Energy (DOE) Compliance and Certified, ASTM Test 518, ASTM Test E84

LAYOUT OPTIONS (Please select a layout)

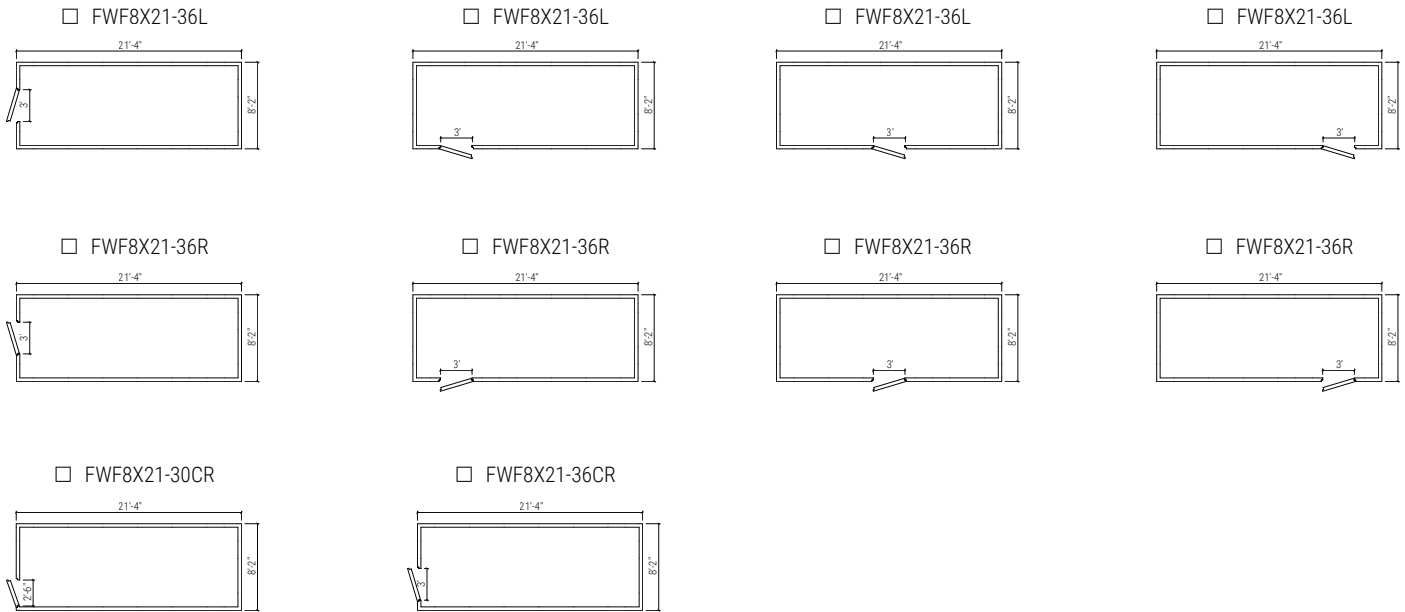

DOOR OPTIONS (Please select a door)

Select door width:

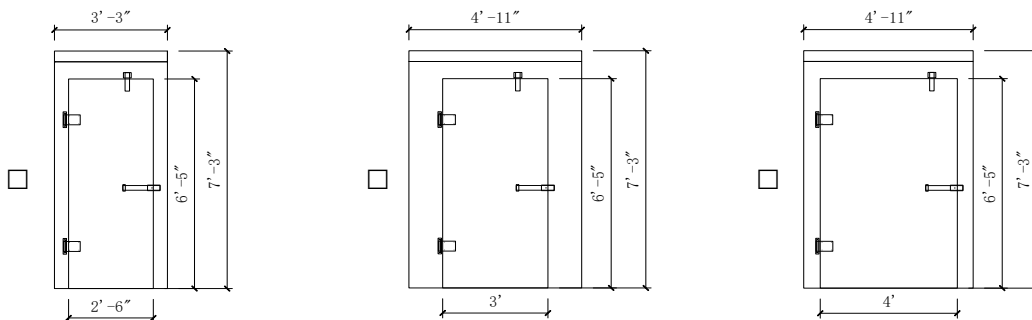

Select left/right hinge:

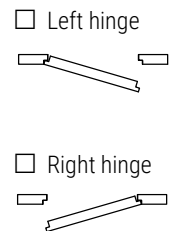

ADDITIONAL OPTIONS

- Kick Plate (Interior and Exterior)
- 4 feet LED light (loose)
- Aluminum diamond plate for floor, 1/8" thick
- Aluminum diamond plate for floor, 1/4" thick
- Exterior ramp
- Rain roof membrane for outdoor application

OPTIONAL REFRIGERATION SYSTEM (Please select a refrigeration type)

Remote Refrigeration (Turbo Air)



Turbo air
REFRIGERATOR MANUFACTURER

1 x Turbo Air Outdoor Condensing Unit, 4.5 HP, Low Temp, Air Cooled, 208-230V/60Hz/1Ph, Copeland Scroll Compressor, R404A, R407C, R448A / R449A

1 x Turbo Air Evaporator, Electric Defrost, EC Motor, Pre-Assembled (R448A, R449A TXV, Solenoid Valve, Digital Temperature Controller), 4 Fans, 15,700 BTU, 208-230V/60Hz/1Ph

1 year parts warranty | Additional 4 years warranty available

Top-Mount Refrigeration (Turbo Air)



Turbo air
REFRIGERATOR MANUFACTURER

2 x Turbo Air Indoor Package Unit, Top-Mount, Smart 7, Low Temp, 5,500 BTU, 208-230V/60Hz/1Ph, R290

Blue Anti-corrosion-fin and Coated Copper Tube, Expansion Valve & Solenoid Valve, Hot Gas Defrost, Efficient Micro Channel Condenser Coil, Energy Efficient EC Motor

Hot Gas Condensate System (Panel Opening Size: 25" x 38.5")

1 year parts and labor warranty | Additional 4 years warranty available

OPTIONAL DISPLAY GLASS DOORS

of 24"x75" doors: _____

GENERAL SPECS:

- Triple-pane for freezer, double pane for cooler
- 7 Wire Shelves
- Black frame and shelves
- Left hinge doors (field reversible)
- LED lighting



Net Opening Dimensions:

Set	Net Opening (Cooler or Freezer)	Electrical
5 Glass Door Set	124"x77.5"h	120V/60Hz/16A
4 Glass Door Set	99.5"x77.5"h	120V/60Hz/12A
3 Glass Door Set	75"x77.5"h	120V/60Hz/10A
2 Glass Door Set	50.5"x77.5"h	120V/60Hz/7A

CUSTOMER APPROVAL

Name: _____

Signature: _____

Date: _____



899 Newark Tpke, Kearny, NJ 07032

Tel: (908) 315-3222

www.GalaxyGroupCorp.com

Email: contact@GalaxyGroupCorp.com